

# **X Series Combines and Front-End Equipment Optimization**

**“Ready To Harvest” for Canola**



**John Deere Harvester Works**

# Contents

|  |     |
|--|-----|
| Attachments for HD & RDF headers.....                          | 3-4 |
| Recommended Draper Adjustments.....                            | 5-7 |
| Draper Inspection and Adjustments.....                         | 8   |
| Combine Configuration and Setup.....                           | 9   |
| Feeder House.....  | 9   |
| Feed Accelerator & Rotor Speeds.....                           | 10  |
| Concaves & Separator.....                                      | 11  |
| Cleaning Shoe Chaffer and Sieve.....                           | 12  |
| Active Tailings & Chopper/Residue.....                         | 13  |
| Barley Adjustment Checklist ( <i>Outside</i> ).....            | 14  |
| Barley Adjustment Checklist ( <i>In-Cab adjustments</i> )..... | 15  |
| Start of Harvest Checklist/Tips.....                           | 16  |
| Cleaning System tips.....                                      | 17  |
| Grain loss Calculation.....                                    | 18  |
| Harvest Productivity.....                                      | 19  |
| Grain Quality & Tough Threshing Tips.....                      | 20  |
| Harvesting Terraces with HD & Grain Tank Cleanliness.....      | 13  |

## **Preface**

The content of this material is intended to help you know how to choose the best configuration and set up an X Series combine and platform, for any Canola crop and condition before going to the field.

Combine and Field installed bundles are explained for attachments, to enhance performance and Grain Quality in specific Canola conditions.

Setup and Adjustment recommendations are intended as a starting point before harvest season. Additional adjustments and fine tuning will be necessary depending on crop moisture and harvest conditions.

Crop setting checklists and Grain Quality Tips are a quick reference for configurations and operating speeds to help optimize grain quality.

## Attachments for HD & RDF headers

### Divider Rods (*HD & RDF*)

Optional divider rods can be installed to help divide the crop and help prevent material wrapping between the end of the reel and divider point.



### Side Knives

Side Knife crop dividers can be utilized to help split bushy crops and help promote crop flow without bunching or crop hanging up on the end dividers.



### Back Sheet Extensions

These extensions add additional back sheet coverage for large volume bushy crops. This extra coverage helps prevent header grain loss.



### Top Augers

Top augers push large volume crops against the draper belt to help convey crops to the center of the head.



### Fingered Top Augers

Fingered augers provide additional leverage in bushy crops to help convey the crop to the center of the head.



### **Grain Saver Draper Belts (HD only)**

Optional side belts designed for small grains to help prevent header grain loss in shatter prone crops.

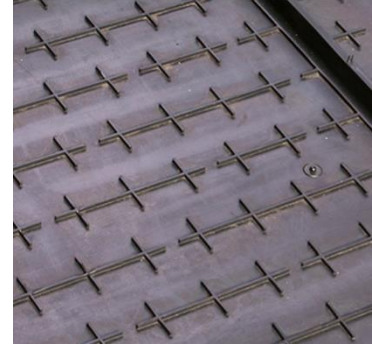

### **Cleated Center Belt**

Recommended for cereals, oil seed, and pulse crops.



### **Standard Center Belt**

Recommended for soybeans to promote feeding and minimize grain loss at the center section. (RDF option Only)



### **Center Crop Flow Divider**

Recommended for light crop to minimize underfeeding. (RDF & HD)

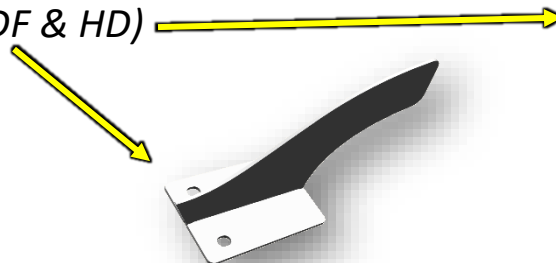

### Center Section Seal Kit

The center-section seal kit minimizes grain loss due to pod shatter when direct cutting canola. **Note:** For best performance when harvesting cereal grains, it is recommended to remove the left- and right-side seal components.



### Reel Flip-Over Bundle

Recommended to reduce reel wrapping. (Not compatible with Steel Tine Standard Reel)



### Steel Crop Dividers (HD only)

For use in Extremely Heavy, High Yielding, Wet straw Cereal Grains. Advantages are seen more with Auger Platforms. (Dividers can be stored on the back of the head when Side Knives are installed.)



### Crop Lifters

Install brackets to help prop up down lying crops. (Only recommended for off-ground harvesting.)



### Gauge Wheel Scrapers

Recommended to reduce gauge wheels from accumulating material which could cause inaccurate header height position for off-ground cutting. (Gauge wheels only available on HD)



## Recommended Draper Adjustments

**Reel Position:** the reel needs to only assist crop over the cutterbar onto the side belts. The reel should be operated high and further out. **Up and Out to prevent grain loss due to pod shatter.** Reel speed should be matched with the ground speed. A reel speed that is TOO FAST Can lead to pod shatter and cause header loss.



### Reel Finger Pitch

Reel Fingers should be adjusted to least aggressive or for crop condition:

- Most aggressive position (pulled back) for down or tangled crop.
- Medium aggressive position (leaned back) for normal crop conditions.
- Least aggressive** position (Straight down) for tall standing crop.



## Draper Belt Tension

Check and adjust the draper belt tension on both sides of the header. Adjust so the indicator is in the center of the gauge.

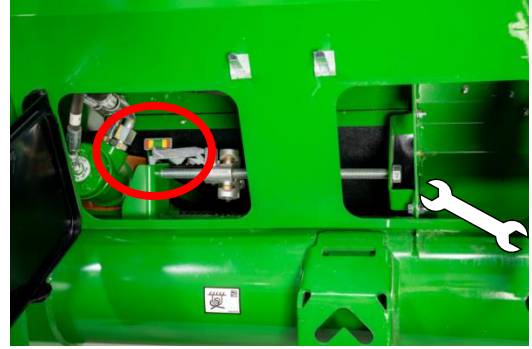

## HD Center Draper Belt Tension

Both sides of the center belt will need to be checked. If necessary, tension or de-tension the belt according to the gauge.

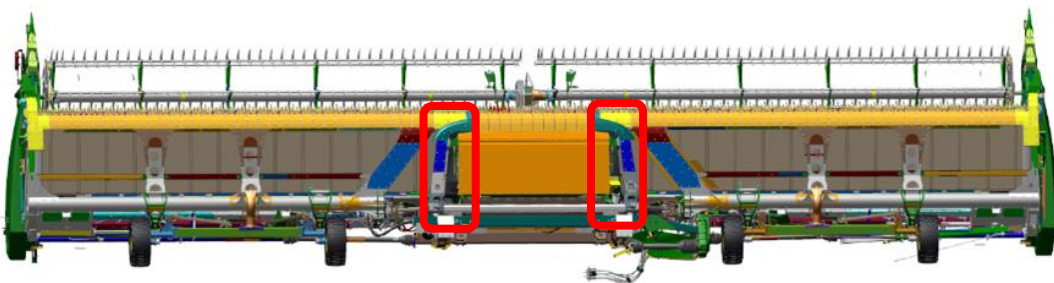
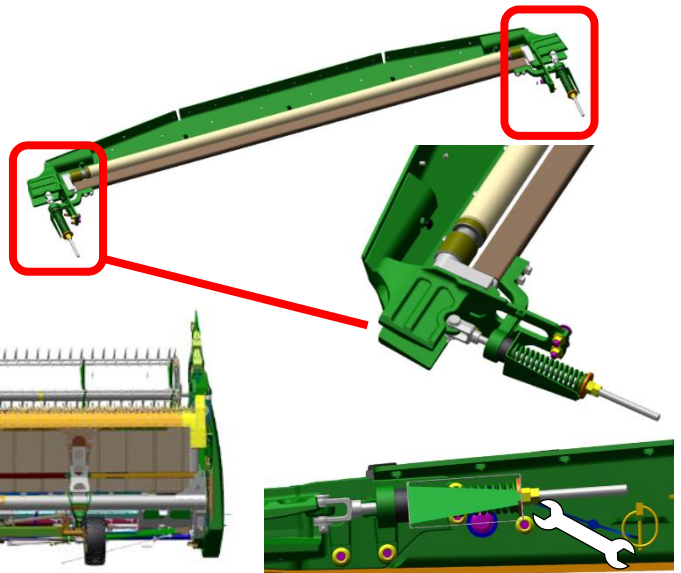



**Reel Finger Clearance** – Proper setting of minimum reel height will protect against unexpected reel movements that can place reel fingers in contact with cutterbar.



**RDF:**



**HD:** With the wings in the down, measure 45mm at the outer reel fingers and 15mm at hinge.



### **Drum Height Position**

The drum height can be raised for higher capacity feeding of high-volume crops.

*HD heads have a jack bolt on the sides of the drum for height adjustment.*

### **Feed Drum Finger Timing**

With the center feed section in neutral, spin drum until the middle finger has the lowest clearance to the feed floor, this gap should be 40mm. Use handle on RH side of drum to adjust.



## Draper Inspection and Adjustments

The following adjustments are critical to ensure that the RD/HD Draper performs to its optimum:

- Sickle Sections
- Knife Guards
- Dual Knife Timing
- Reel Finger Timing

**For Optimal performance and durability of cutting components:**

### **Fine Tooth Sections recommended for Canola harvest.**

- Inspect for broken or improperly adjusted hold downs. Repair or replace as required.
- Inspect for dull or broken knife sections. Repair or replace as required.
- Inspect for dull or worn or broken guard cutting edges. Repair or replace as required.
- Inspect for excessive binding between top of knife sections and top of guard slot. Binding can be caused by bent guards, bent cutterbar or improper position of guards. Repair or replace as required.
- Inspect knife head and knife drive alignment with first guard slot to ensure binding is not present in areas. Repair or replace as required.
- Verify knife hold downs are tight. Knife gap should be the thickness of a business card.
- Verify that complete cutting system turns freely by rotating the drive by hand (drive shaft removed). **Keep hands and fingers away from cutting components while rotating!**

## Combine Configuration and Setup

### Feeder House Drive Chain Speed

- Conveyor chain drive speed – Slow 22T larger diameter sprocket for high material volume canola crops.

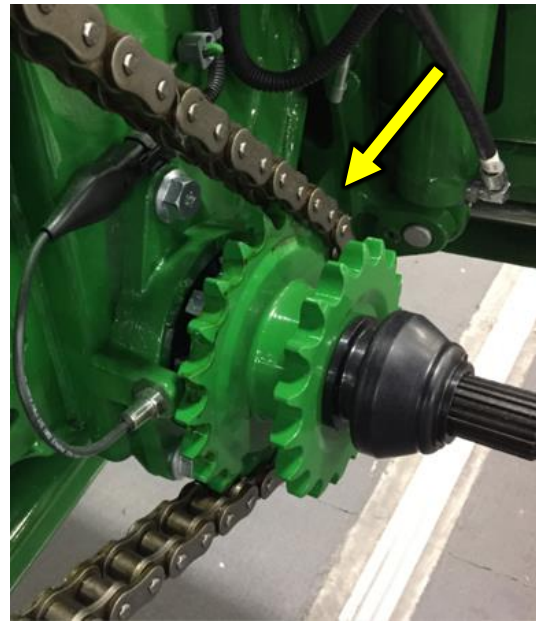

### Feeder House Drive Chain Tension



18 – 25mm  
Check every 50hrs

Replace chain when Idler has reached the end of adjustment slot.

## Back-Shaft Speed Feeder House Variable Drive

- Operate the cutterbar slow 520rpm



## Rotor Speed

- 2<sup>nd</sup> Gear (420-800rpm range)

## Feed Accelerator Speed

- High speed 2<sup>nd</sup> Gear – 990rpm
  - W/optional Slow Speed Kit – 698rpm
    - *The Slow Speed Kit is recommended for improved grain quality in Corn.*



## Optional Slow Speed Kit

New Pulley & Belt

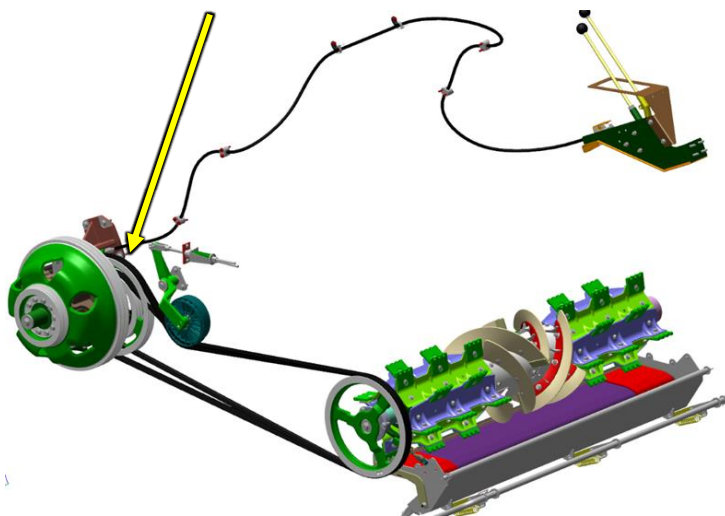

## Concave Configurations

**Small Wire (SSS)** Concaves recommended in all three positions for harvesting small grains. Overall performance is very good in all moisture conditions. Concaves are half width for ease of handling when changing for other crops. Refer to your Operators Manual for how to Level Concaves (front to rear) and calibrated to “Zero” on clearance to the threshing elements.

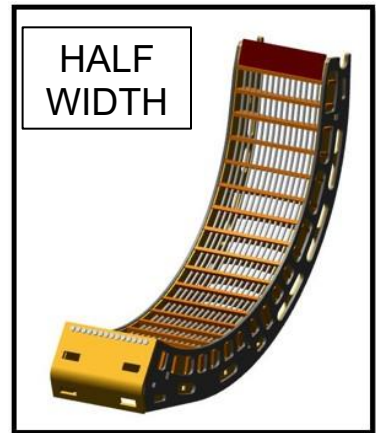

**(SSL)** Using a Large Wire concave in a SSL configuration is great for the vast majority of harvest conditions in European countries. It is robust enough for high yield cereal grains, providing adequate threshing and separating to match combine performance goals.

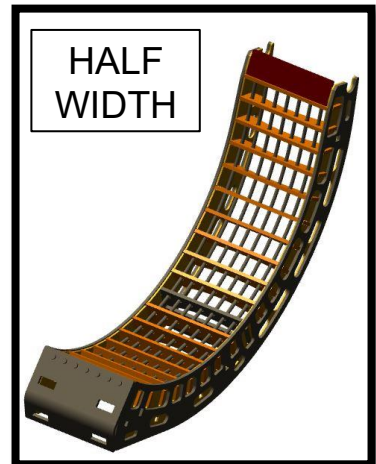

**Concave Covers** can be added for most conditions where threshing is not adequate.

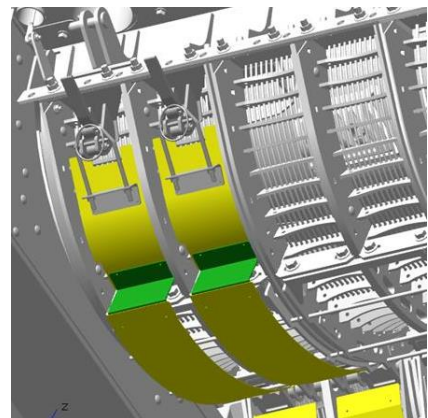

## Separator Grates

Be sure separator grate spacers are in the storage position with the grates flush against the rail for small grains. This will need to be done on both sides of the machine for both rotors to match. Also make sure to reinstall deflector shields.

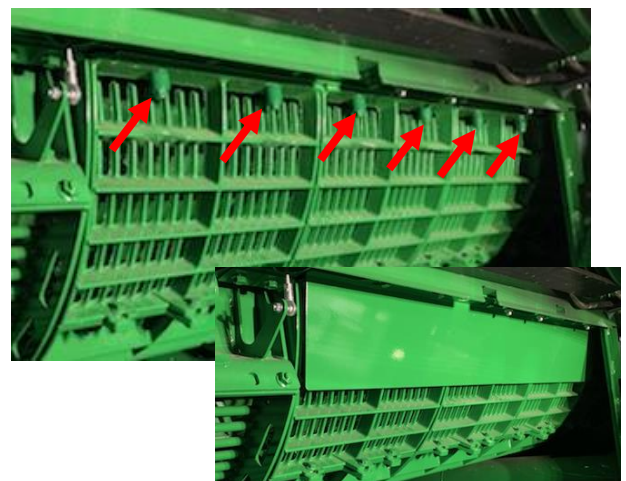

**Separator Grate Covers:** Covers a full separator grate for use in dry, high chaff conditions to improve cleaning shoe performance. Up to 2 on each side can be installed.



## Cleaning Shoe

### General-Purpose

Chaffer and General-Purpose Sieve are recommended for Canola.



### Flat Tooth Comb (FTC Chaffer)

Prevents longer sticks from passing through the chaffer reducing the tailings by 23% and improving the grain tank sample.



Be sure chaffer and sieve are calibrated so the opening exactly matches the cab display setting.

*If openings do not match, follow the Factory Cal procedures.*

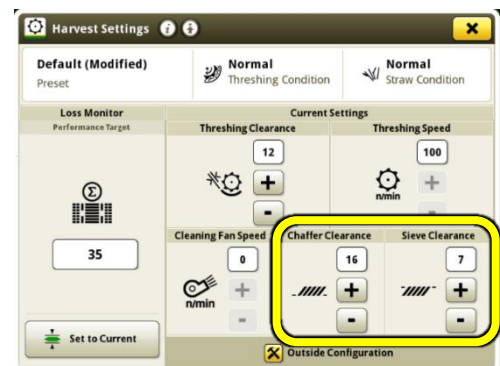

### Sidehill Performance Package

Recommended for sidehill conditions to help retain a level shoe load in sidehill conditions for proper grain cleaning and preventing grain loss from uneven and overloaded bays. Includes full-length tall chaffer dividers and crop deflectors.

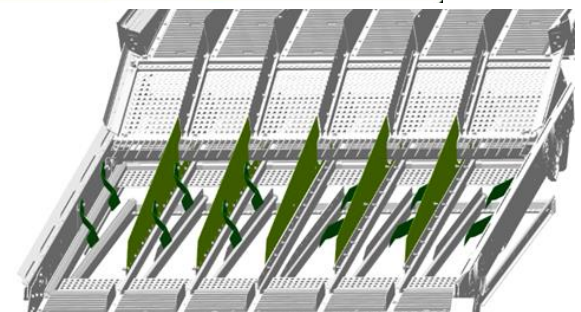

Front chaffer should be set at 25mm for ALL crops.



### Active Tailings System

Set the lever UP to the **CORN** position to open the concave to reduce chaff load on the chaffer and sieve. In Shatter Resistant Canola, change to the DOWN SMALL GRAINS position to help with additional threshing.

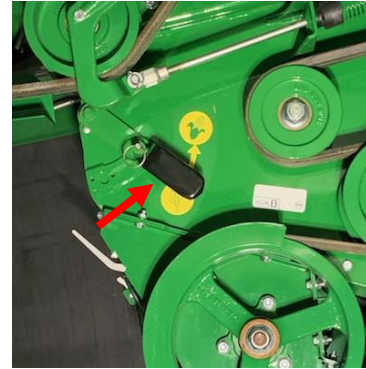

### Chopper speed in High

Push lever in, to small grains position.

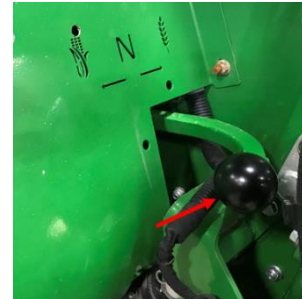

### Adjustable Knife Bank Engagement

Depending on preferred residue size.

- Manual engagement
- In cab adjustment (if equipped.)



### Additional Residue Sizing Option

Adding the straw chopper controller bar reduces the stem cut length when desired. The controller bar is installed to the chopper floor.

*Risk: Controller bar increases horsepower usage.*

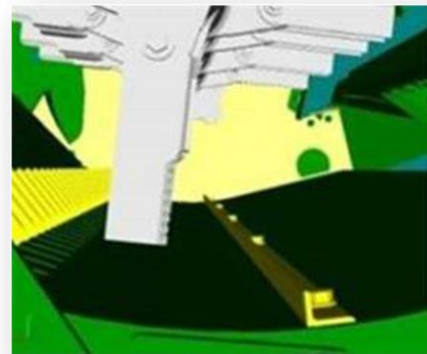

**Wide Shrouds:** If having trouble spreading 50ft+, these can help increase spread width

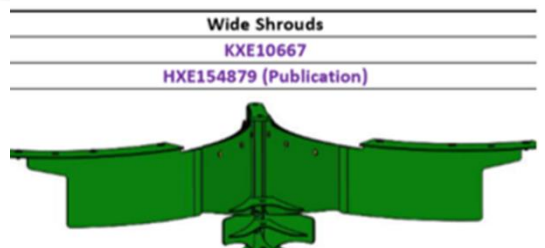

## Canola Adjustment Checklist (*Outside*)

### Front End Equipment

- Reel Finger pitch set in the middle (position 3) for moderate aggressiveness. *Adjust as needed to crop condition.*
- Center Section set on high speed.
  - *If in very dry conditions the center section in low can reduce head shelling.*
- Unpin Automatic Header Height Control sensors (*RDF*)

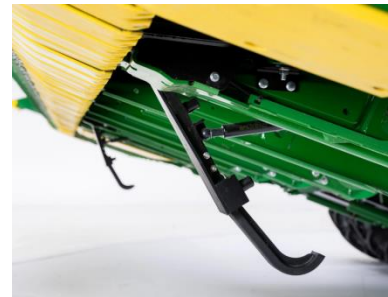
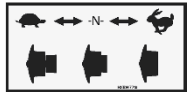
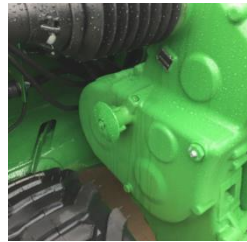

### Feeder House

- Feeder House Drive Chain Speed = 22T for high volume corps
- Feed Accelerator shifted into High Speed 2<sup>nd</sup> Gear
- Rotors shifted into 2<sup>nd</sup> Gear (420-800rpm range)

### Cleaning System

- Measured Chaffer and Sieve settings match display
  - Left and right side of elements match
- Front chaffer set to 25mm (All crops)
  - *Closing the front chaffer can nozzle air flow and reduce capacity*

### Separator

- Separator grate spacers in the storage position
- Concaves zeroed/leveled (*SSS* recommended)
- Install separator covers if needed to even out shoe load
- Active tailings Set to Corn position

### Residue

- Counter knife engaged only as far as required
  - *Over chopping takes more power and fuel*



## Canola Adjustment Checklist (In-Cab adjustments)

- Back shaft Speed = 520rpm
- Cleaning Fan speed = 570-800rpm
- General Purpose Chaffer = 10-19mm
- General Purpose Sieve = 3-7mm
- Front Chaffer = 25mm
- Rotor Speed = 550-850rpm
- Concave Clearance = 15-35mm

### Auto Header Controls

- Height Resume
- Height sensing *off-ground*
- Lateral Tilt
- Fore/Aft Resume
- Auto Reel Speed
- Auto Belt Speed

- *RDF headers will have the ability to run both Off-Ground and On-Ground height sensing for harvesting in down crop conditions.*

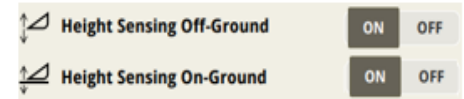
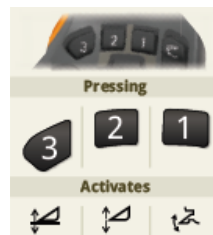

- Set the Ground Conditions Settings (HD)

- Very Firm
- Firm
- Typical
- Soft
- Very Soft

**Note:** *The Softer the setting the more "ridged" the suspension.*

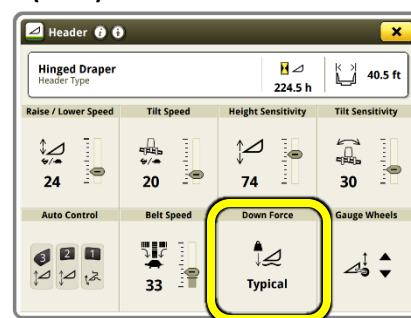

- Set the Ground Conditions Settings (RDF)

When cutting off-ground, increase cutter bar pressure to Max HydraFlex pressure.

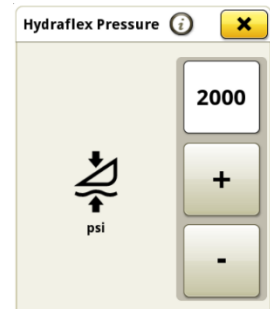
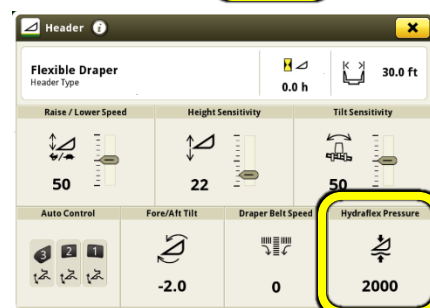

## Start of Harvest

- ❑ Rotate the left- and right-wing manual override valves clockwise to the harvesting position & verify the left and right Service wing lock safety valves are vertical in the unlocked position.
- ❑ Measure crop and set header cut height.
  - Depending on the desired amount of remaining stubble, cut height should be as high as possible without missing low hanging pods.
  - Taking in excessive straw consumes more power, fuel and can increase losses.
  - This is especially true in green/tough straw conditions where wet material can hinder separation.
- ❑ Set reel position. Reel Finger angle position for minimal disturbance to the crop, helping the crop onto the belt minimizing head shatter. Adjust reel finger angle adjustment handle away from cutterbar.
- ❑ Set Draper Belt Speed. Belt speed should be matched to machine ground speed and/or crop conditions for optimum feeding performance.



Manual Override Valve & Safety Wing Lock Ball Valve Unlocked

**Too Slow:** Crop is feed too far on outsides, can cause crop wrapping under belts, and bunching in feed drum

**Optimal:** 2 streams from belts just barely come together making a smooth wide stream of crop entering drum. This ensures each rotor is fed evenly

**Too Fast:** Both belt streams come to together in the center intermixing the crop, creates 1 stream which is difficult to utilize the full width of the separator. Can create slug feeding and drum plugging

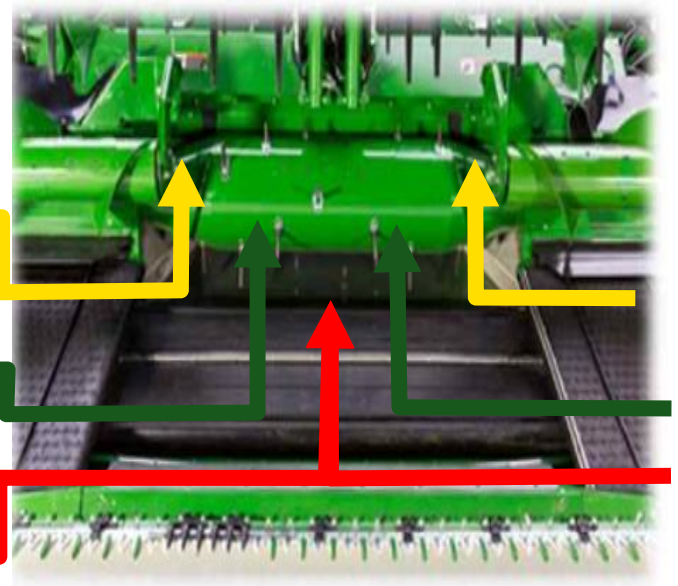

- ❑ If stalks are green and fine sections are having difficult time cutting stalks (pulling out of ground, etc) Consider coarse tooth knife sections in these conditions.
- ❑ Run the Top Conveying Augers slightly faster than draper belts.
  - *1 pitch of flight should overtake side belt cleat.*
- ❑ Finger drum timing should be fully counterclockwise.
- ❑ Recommend center section speed set to “High.”
  - *If conditions are very dry and pre-threshing pods, set to “LOW.”*
- ❑ If plugging occurs within the header center section, you can raise the feed drum to high position.
- ❑ If Top Augers become wrapped, ensure stripper setting has 5mm clearance from the auger flighting.
  - *Fingered Top Augers - time fingers so they are fully retracted at the stripper.*

### **Grain Quality:**

- In Canola/OSR understand at what level of grain quality dockage occurs at. If targeting below 1-1.5% Foreign material in the grain tank can begin reducing combine productivity.
- Use grain quality as a method to find a balance between losses and productivity.
- **KNOW** the amount of FM (foreign material) in the grain tank. Over cleaning can create unnecessary losses.
  - **Note:** *The grain tank loading auger causes debris to concentrate out the outside of the grain tank, next to the glass, ensure looking at total sample from trucks or grain cart to get full perspective before assuming too dirty.*
- Collect a ~1kg/2lb sample and use an 8/64” screen to separate the MOG from the grain.
- Pay close attention to grain damage in canola/OSR, especially in tough to thresh varieties. Split, yellow seeds will be visible in the tank if grain damage is in excess.
- If the sieve is closed much tighter than 4mm, it can begin to choke off air to the main chaffer and prevent separation, close chaffer instead to reduce MOG on the sieve.

## Ensure pods are being properly threshed!

- This is the most important rule of canola optimization, when setting the combine lay a windrow and check the straw for threshed pods.
- Full/Partially threshed pods can fall to the shoe and appear as shoe loss. *Note: Check chaff on tailboard for un-threshed pods.*
- Only be as aggressive as needed, **do not over thresh!** If shoe is overloaded, it will increase losses.
- Weather events like frost, rain, heat, can change pod condition day to day.
- Ensure grain is fully threshed from pods in tailings.
  - *If unthreshed pods are present, Set Active Tailings position to the "Grain Position."*

## Pod Thresh Ability Test

- Gather 10-15 full pods in your hand and give 1 good squeeze.
  - If the majority of the pods break open and release their seeds, you can harvest with more open and less aggressive settings.
  - If very few of the pods break open, you will need to run the most aggressive settings (ex. 5-10mm concave and 900rpm rotor.)
  - If ~half of the pods break open and pods are not crispy you will need to run settings with moderate aggressiveness on the separator, but could need to be more aggressive when dew sets in.

## Conditions Examples – It's not only Shatter resistant varieties!

1. Shatter resistant, >10% moisture, green stalk, fungicide applied
2. Conventional, <10%, windrowed, had not been rained on since swathing, pods green and very hard.
  - After a heavy rain, this condition went back to more conventional easy threshing settings due to windrow getting wet and drying out, curing more



A lot of these small broken pods can be found intermixed in the chaff.



Pods which were threshed and broken open but still have seeds in them and very hard to thresh.

## Overloading the cleaning system with chaff

- In dry or tough to thresh conditions, excessive chaff on the cleaning system can reduce capacity. To mitigate this, do the following:
  - Install full separator grate covers to cover up to 2 full separator grates to reduce chaff loading
  - Ensure machine is not over-threshing and processing the straw excessively
  - As a general guideline, after power shutdown if chaff on chaffer is above the bay dividers work to reduce the chaff with grate covers and settings changes
  - Air from the cleaning fan will take the path of least resistance. Ensuring the chaff load on the shoe is balanced will allow for a cleaner grain tank and prevent grain loss.



Notice chaff level is at top of dividers, in this condition, attempt to reduce chaff with less aggressive settings and/or separator



Same field, same condition with grate covers and optimized settings, notice reduced chaff on chaffer and more exposed dividers

- Cut as high as possible to take in a minimal amount of the plant, this is especially true in green stalk conditions where the wet material can hinder separation.
  - In dry conditions any extra material harvested can be easily ground up and overload the cleaning system.

Harvest a short distance, perform a power shutdown and inspect machine/ground for leaks, grain loss, and grain tank cleanliness.

- Header to Feeder House connection
- Stone trap seals
- Shoe seals
- Auger trough and grain tank clean out closed

### Checking Harvest Loss

1. Preharvest loss
2. Header loss
3. Machine loss
4. Rotor loss
  - a. Un-threshed loss
  - b. Threshed loss
5. Shoe loss



### Calculate Loss Equipment Plus App

1. Verify crop type
  - *Change by selecting the menu at the top right of the screen*
2. Identify Residue Disposal
  - Spread
  - Windrow
3. Input the Header Width
4. Input the current Yield
5. Measure and input the Seed Count grain loss found
6. Identify the Area measured for known seed count

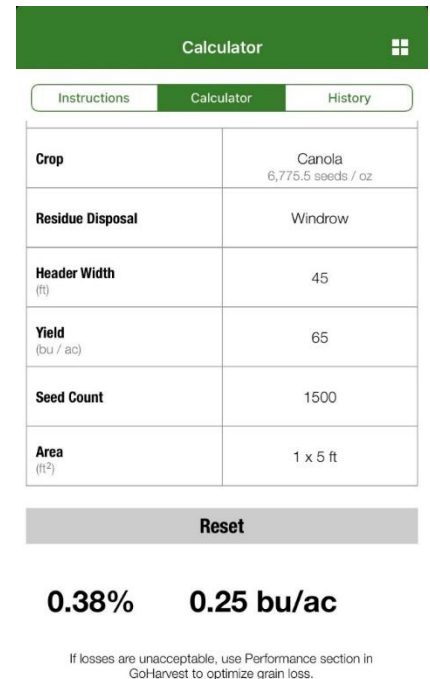

### Grain Loss Algorithm

Starting in Model Year 2022, X Series and S Series machines come set with the Area-based grain loss algorithm as default.

*Area-based loss display algorithm is similar in units of kernels per area. The algorithm considers machine header width, speed, and loss levels. The area-based logic should be the most consistent display algorithm option when harvesting over a range of different speeds and crop conditions, along with the most correlation with the above traditional grain loss checks on the ground behind the machine.*



## Harvesting Productivity

Grain feed rate (bu/hr or tn/hr) is an important factor in harvest optimization that is easy to overlook. Ground speed may remain the same but as grain feed rate changes this can affect losses significantly.

- Verify losses as feed rates increase to maximize efficiency.
- Use display to monitor changes in bu/hr or tn/hr

The 3-stage rotor chamber helps crop expand as it travels through the rotors for improved separation. Slightly faster than traditional rotor speeds are necessary for the X-Series as the Dual 24in rotors are smaller than the Single 30in S-Series rotor. The increase in RPM is to match the equivalent rotor tip speed of the Single rotor. With faster speeds, more centrifugal force is applied to the heavier grain. This force helps separate the grain from the MOG as it travels through the rotor cage.

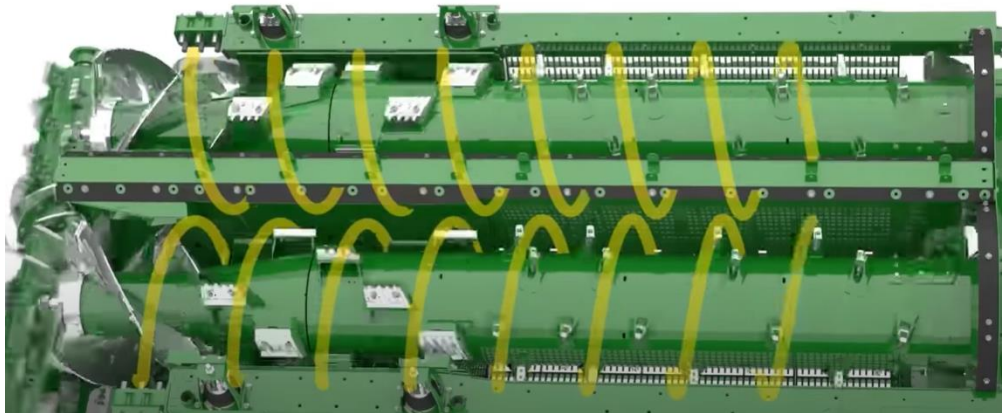

# Harvesting Swathed Canola

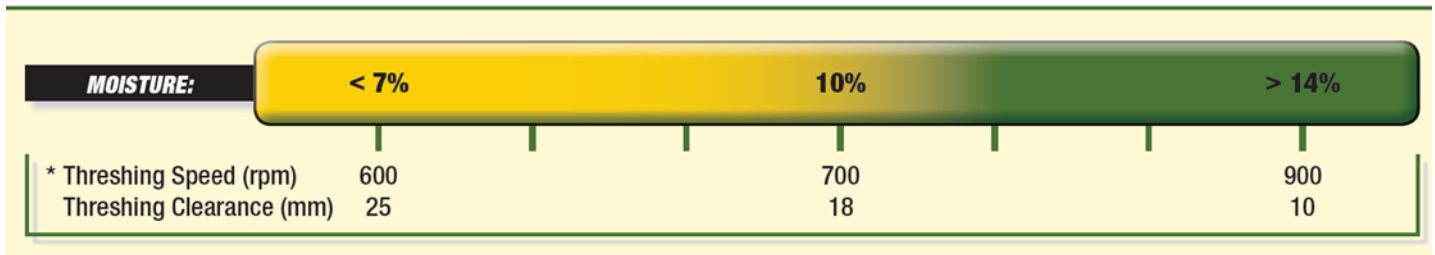

- Feeder house drive chain sprocket normal setting is 15T, then change to 18T for tough conditions.
- Adjust BP15 gauge wheels to minimize dirt, debris, and rock intake.
  - *In tough conditions, if experiencing auger plugging, first increase auger speed and set to 18T tooth sprocket.*
  - *If still occurring, raise the auger position.*
- If harvesting dry, nicely laid windrows, rotor speed can be slowed as low as 500rpm to minimize chaff loading if needed.
  - *Excessive load on Separator Drives can be avoided by increasing rotor speed in tough Canola.*
- Ensure windrow is centered on the feeder house/BP15. this ensures even splitting of the crop between the 2 rotors and reduce the risk of overloading 1 rotor.
- If windrows are very tough and windblown/poorly laid, increasing rotor speed to ~800-900rpm can aid in material handling to smooth out feeding.
  - *Separator grate covers may be needed to reduce chaff loading.*
  - *Opening sieve and/or reducing chaffer settings. Changing fan speed can aid in fluidizing chaff reducing chaff flow to tailings. Incorrect settings of fan can greatly affect tailings levels if not blowing chaff out or pushing grain too far rearward for adequate separation.*
- Minimize free grain in tailings as much as possible.
- Installing full separator grate covers over the first 2 grates can help reduce shoe loading and reduce losses.
  - When installed, may need to increase rotor speed 50-100rpm to aid in separation.



## Direct Cut Rapeseed (Non-Shatter Resistant, Europe)

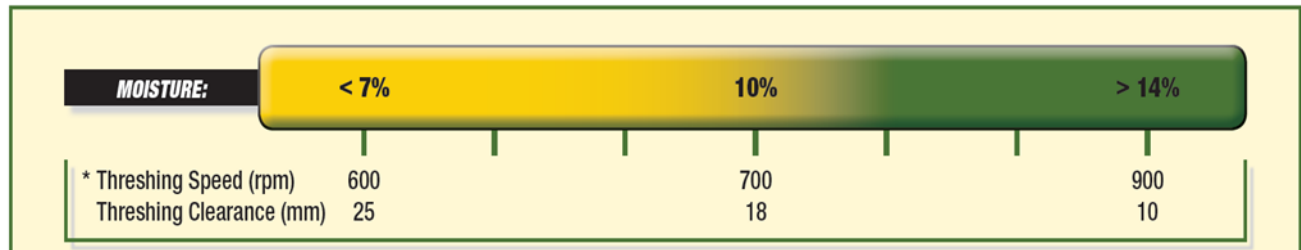

### Dry Conditions

- If harvesting dry OSR, rotor speed can be slowed as low as 500rpm to minimize chaff loading.
  - If still have high shoe loads, install separator grate covers over the first and then 2<sup>nd</sup> separator grates.
- Reducing rotor speed has greater effect on shoe load than concave clearance.
  - Slow rotor before opening concaves beyond 35mm+
- In Dry conditions, the feed drum on the header can pre-thresh the crop, set speed to low gear to reduce pre-threshing.
- If conditions allow run Feed Accelerator on slow.

### Green Stalk Conditions

- If experiencing losses when stems are green, and grain is dry, slow rotor, open concave and Feed Accelerator in 1<sup>st</sup> gear to reduce straw breakage. The sap from the broken straw can be released causing the kernels to stick to the straw and not be separated.
- Need to compromise between not squeezing moisture out of material and create Separator loss. Need to have rotor speed slow and concaves open enough to get the seeds separated and maintain a smooth crop flow.
- Reducing rotor speed has greater effect on straw breakage than concave clearance.
  - Slow rotor before opening concaves beyond 35mm+
- Due to low chaff, some conditions may allow for more open shoe settings.

## Grain Tank Cleanliness for Canola

- **Problem**

- *Sticks and stalk pieces in grain tank*

- **Solution**

- Increase fan in 50RPM increments without throwing grain out the back.
- Close chaffer opening by 2mm to help remove sticks and pieces.

- **Customer Concern**

- Excessive tailings/tailings plugging.

- **Solution**

- Flat Tooth Comb (FTC Chaffer)

**Key Feature:** *Curled finger*

**Advantage:** *Prevents longer sticks from passing through chaffer.*

*Reduced Tailings - Testing has shown an over 20% reduction in tailings.*

*Improved Grain Tank Sample*

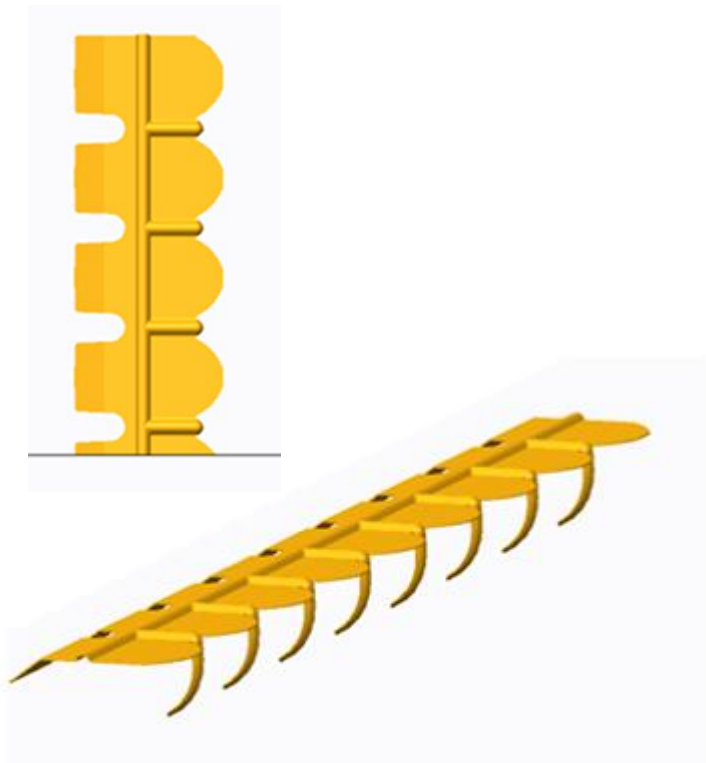

## Harvesting Perpendicular to Terraces with HD Headers

---

- **Problem**

- *Harvesting Perpendicular to the Terrace with HDR headers.*

- **Solution**

- Hydro handles button 2 and 3 can save cut height, HFAT, ground condition for quick changes between heights.
- Holding the feeder house/head lower button will lower the cutter bar without disabling height sensing when the button is released the head will returned to previously set target.
- Cut height encoder/dial on the arm rest can be used for adjustments to cut height without accessing header page.

Download the Equipment Plus App for quick information on, settings, grain loss calculator, JDParts, videos, procedures and much more.

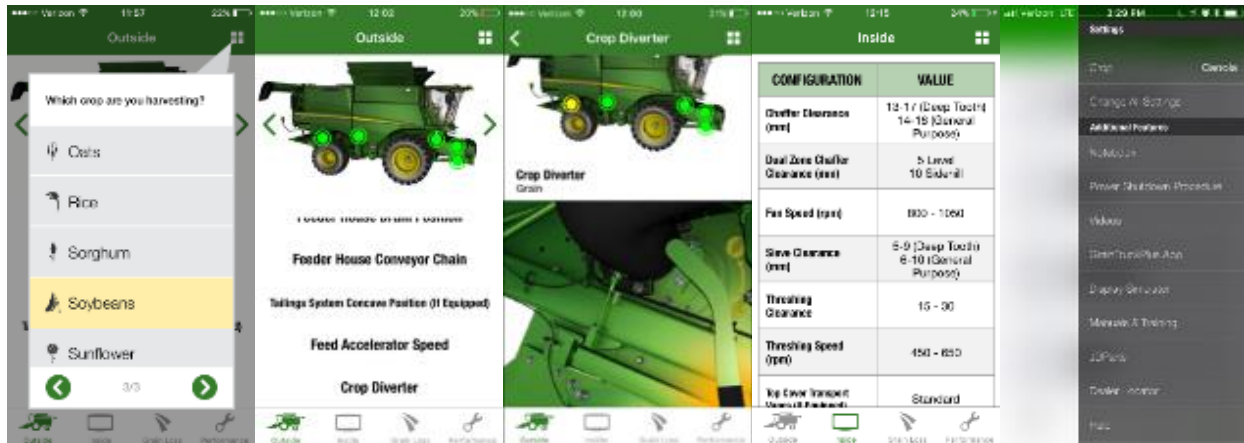

Visit the GoHarvest YouTube channel for detailed videos on Power Shutdown procedure, CombineAdvisor, ActiveTerrain Adjustment, and many more.



<https://www.youtube.com/watch?v=3KR77OTdNKU&list=PL1KGsSJ4CWk7jzH744F1bByhwXWAlxmFj>

## NOTES

---

---

# Loss Worksheet



JOHN DEERE

